



WSxxP15SMC(-B)

Power Transient Voltage Suppressor

Features

- 1500 watts Peak Pulse Power (10/1000 μ s)
- Unidirectional and Bidirectional Protection
- Fast Response Time: Typically < 1ns
- Excellent Clamping Capability
- Built-in Strain relief
- Low inductance
- Low profile package
- IEC 61000-4-2 (ESD) \pm 30kV(air), \pm 30kV(contact)
- MSL: Level 1

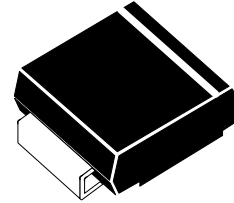

SMC
(JEDEC DO-214AB)

Mechanical Characteristics

- JEDEC DO-214AB package
- Molding compound flammability rating: UL 94V-0
- Marking : Marking Code
- Packaging : Tape and Reel per EIA 481
- RoHS & HF & UL497B Compliant

Applications

- I/O Interfaces
- Power lines
- Telecommunication
- Computers & Consumer Electronics
- Industrial Electronics

Absolute Maximum Rating			
Rating	Symbol	Value	Units
Peak Pulse Power (tp =10/1000 μ s) (see Note1,2& 3)	P _{PPM}	1500	Watts
Peak pulse current (10/1000 μ s) (see Note2& 3)	I _{PPM}	See next table	A
Peak forward surge current (see Note4& 5)	I _{FSM}	200	A
Power dissipation on infinite heat sink T _L = 50 °C(Fig5)	P _D	6.5	W
Operating junction temperature range	T _J	-65 to + 150	°C
storage temperature range	T _{STG}	-65 to + 150	°C

Note1: Peak Pulse Power Rating as Pulse Width , per Fig1.

Note2: Peak Pulse Power or Current Derated above T_A=25°C Per Fig. 2 and Non-Repetitive Current Pulse, Per Fig.3.

Note3: Mounted on 5.0x5.0mm² copper pad to each terminal.

Note4: 8.3ms Single Half Sine Wave or Equivalent Square Wave.

Note5: Maximum Forward Surge Current only for Unidirectional Device per Fig6.

Electrical Characteristics

Part Number		Reverse Stand off Voltage V_{RWM} (Volts)	Breakdown Voltage		Test Current I_T (mA)	Maximum Clamping Voltage $V_C@I_{PP}$ (Volts)	Maximum Peak Pulse Current I_{pp} (Amps)	Maximum Reverse Leakage $I_R@V_{RWM}$ (μ A)
			$V_{BR}(\text{Volts})@I_T$					
UNI-POLAR	BI-POLAR		MIN	MAX				
WS5.0P15SMC	WS5.0P15SMC-B	5.0	6.40	7.00	10	9.2	163	800
WS6.0P15SMC	WS6.0P15SMC-B	6.0	6.67	7.37	10	10.3	145.7	800
WS6.5P15SMC	WS6.5P15SMC-B	6.5	7.22	7.98	10	11.2	134	500
WS7.0P15SMC	WS7.0P15SMC-B	7.0	7.78	8.60	10	12.0	125	200
WS7.5P15SMC	WS7.5P15SMC-B	7.5	8.33	9.21	1	12.9	116.3	100
WS8.0P15SMC	WS8.0P15SMC-B	8.0	8.89	9.83	1	13.6	110.3	50
WS8.5P15SMC	WS8.5P15SMC-B	8.5	9.44	10.40	1	14.4	104.2	20
WS9.0P15SMC	WS9.0P15SMC-B	9.0	10.00	11.10	1	15.4	97.4	10
WS10P15SMC	WS10P15SMC-B	10	11.10	12.30	1	17.0	88.3	5
WS11P15SMC	WS11P15SMC-B	11	12.20	13.50	1	18.2	82.5	1
WS12P15SMC	WS12P15SMC-B	12	13.30	14.7	1	19.9	75.4	1
WS13P15SMC	WS13P15SMC-B	13	14.40	15.90	1	21.5	69.8	1
WS14P15SMC	WS14P15SMC-B	14	15.60	17.20	1	23.2	64.7	1
WS15P15SMC	WS15P15SMC-B	15	16.70	18.50	1	24.4	61.5	1
WS16P15SMC	WS16P15SMC-B	16	17.80	19.70	1	26.0	57.7	1
WS17P15SMC	WS17P15SMC-B	17	18.90	20.90	1	27.6	54.4	1
WS18P15SMC	WS18P15SMC-B	18	20.00	22.10	1	29.2	51.4	1
WS20P15SMC	WS20P15SMC-B	20	22.20	24.50	1	32.4	46.3	1
WS22P15SMC	WS22P15SMC-B	22	24.40	26.90	1	35.5	42.3	1
WS24P15SMC	WS24P15SMC-B	24	26.70	29.50	1	38.9	38.6	1
WS26P15SMC	WS26P15SMC-B	26	28.90	31.90	1	42.1	35.7	1
WS28P15SMC	WS28P15SMC-B	28	31.10	34.40	1	45.4	33.1	1
WS30P15SMC	WS30P15SMC-B	30	33.30	36.80	1	48.4	31	1
WS33P15SMC	WS33P15SMC-B	33	36.70	40.60	1	53.3	28.2	1
WS36P15SMC	WS36P15SMC-B	36	40.00	44.20	1	58.1	25.9	1
WS40P15SMC	WS40P15SMC-B	40	44.40	49.10	1	64.5	23.3	1
WS43P15SMC	WS43P15SMC-B	43	47.80	52.80	1	69.4	21.7	1

Power Transient Voltage Suppressor

WSxxP15SMC(-B)

WS45P15SMC	WS45P15SMC-B	45	50.00	55.30	1	72.7	20.6	1
WS48P15SMC	WS48P15SMC-B	48	53.30	58.90	1	77.4	19.4	1
WS51P15SMC	WS51P15SMC-B	51	56.70	62.70	1	82.4	18.2	1
WS54P15SMC	WS54P15SMC-B	54	60.00	66.30	1	87.1	17.3	1
WS58P15SMC	WS58P15SMC-B	58	64.40	71.20	1	93.6	16.1	1
WS60P15SMC	WS60P15SMC-B	60	66.70	73.70	1	96.8	15.5	1
WS64P15SMC	WS64P15SMC-B	64	71.10	78.60	1	103	14.6	1
WS70P15SMC	WS70P15SMC-B	70	77.80	86.00	1	113	13.3	1
WS75P15SMC	WS75P15SMC-B	75	83.30	92.10	1	121	12.4	1
WS78P15SMC	WS78P15SMC-B	78	86.70	95.80	1	126	11.9	1
WS85P15SMC	WS85P15SMC-B	85	94.40	104	1	137	11	1
WS90P15SMC	WS90P15SMC-B	90	100	111	1	146	10.3	1
WS100P15SMC	WS100P15SMC-B	100	111	123	1	162	9.3	1
WS110P15SMC	WS110P15SMC-B	110	122	135	1	177	8.5	1
WS120P15SMC	WS120P15SMC-B	120	133	147	1	193	7.8	1
WS130P15SMC	WS130P15SMC-B	130	144	159	1	209	7.2	1
WS150P15SMC	WS150P15SMC-B	150	167	185	1	243	6.2	1
WS160P15SMC	WS160P15SMC-B	160	178	197	1	259	5.8	1
WS170P15SMC	WS170P15SMC-B	170	189	209	1	275	5.5	1
WS180P15SMC	WS180P15SMC-B	180	201	222	1	292	5.1	1
WS200P15SMC	WS200P15SMC-B	200	224	247	1	324	4.6	1
WS220P15SMC	WS220P15SMC-B	220	246	272	1	356	4.2	1
WS250P15SMC	WS250P15SMC-B	250	279	309	1	405	3.7	1
WS300P15SMC	WS300P15SMC-B	300	335	371	1	486	3.1	1
WS350P15SMC	WS350P15SMC-B	350	391	432	1	567	2.6	1
WS400P15SMC	WS400P15SMC-B	400	447	494	1	648	2.3	1
WS440P15SMC	WS440P15SMC-B	440	492	543	1	713	2.1	1
WS480P15SMC	WS480P15SMC-B	480	536	593	1	750	2	1

Typical Characteristics

Figure 1: Peak Pulse Power Rating Curve

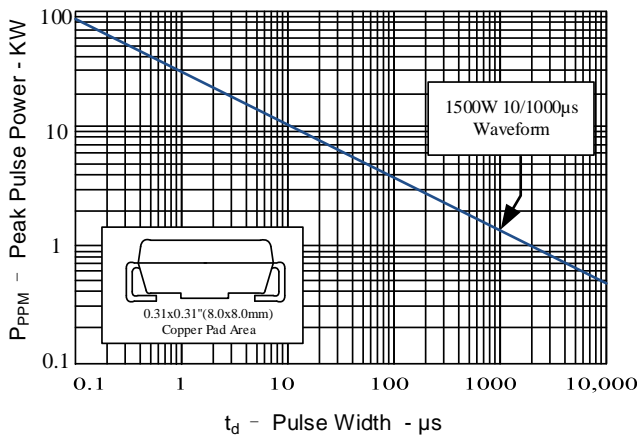

Figure 2: Pulse Derating Curve

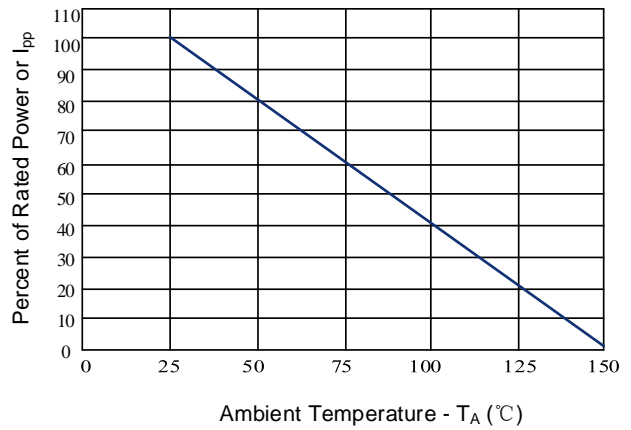

Figure 3: Pulse Waveform

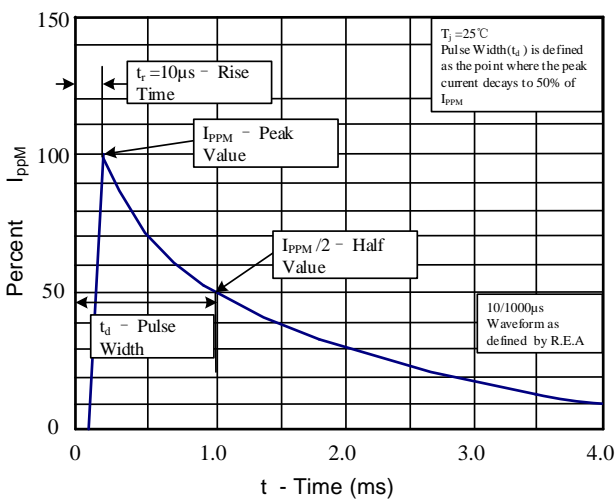

Figure 4: Typical Junction Capacitance

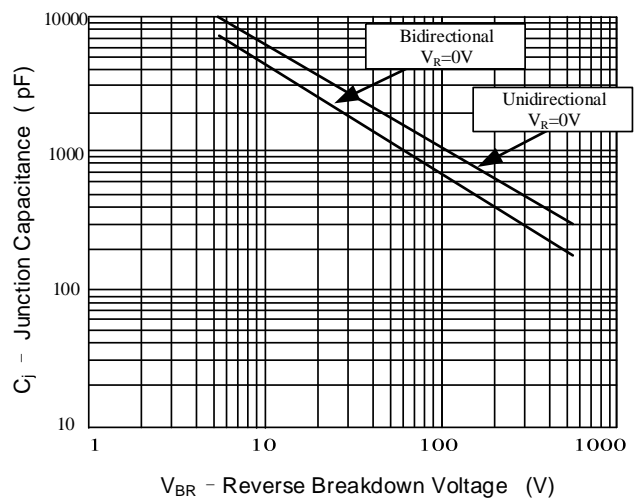

Figure 5: Steady State Power Dissipation Derating Curve

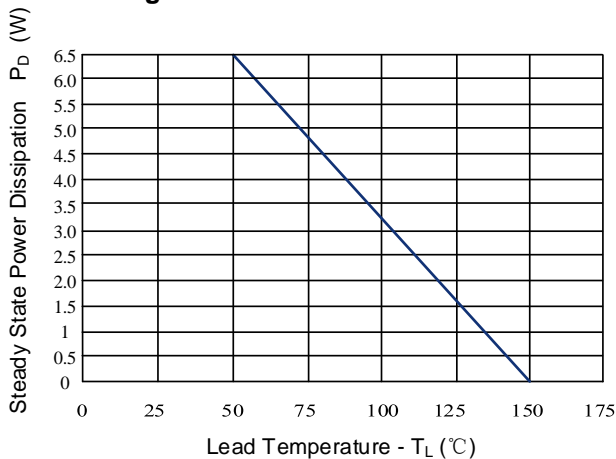
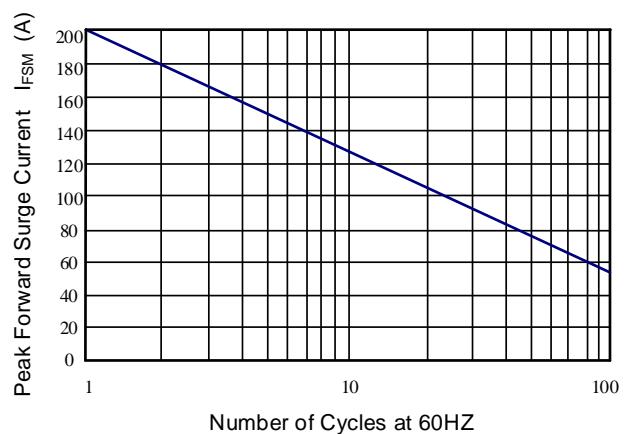

Figure 6: Maximum Non-Repetitive Forward Surge Current Only Unidirectional



Note: The above typical parameters or typical characteristics are only indicative and do not make specific guarantees. If detailed values are required, additional communication and provision are required.

Recommended Soldering Parameters

Reflow Condition		
Pre-Heat	Temperature min ($T_{s(min)}$)	150°C
	Temperature max ($T_{s(max)}$)	200°C
	Time (min to max) (t_s)	60-190 s
Average ramp up rate (Liquidus Temp) (T_L) to peak		3°C/s max
Ts(max) to TL - Ramp-up Rate		3°C/s max
Reflow	Temperature (T_L) (Liquidus)	217°C
	Temperature (t_L)	60-150 s
Peak Temperature (T_P)		260 ^{+0/-5} °C
Time within actual peak Temperature (t_p)		20-40 s
Ramp-down Rate		5°C/s max
Time 25°C to peak Temperature (T_P)		8 minutes max
Do not exceed		260°C

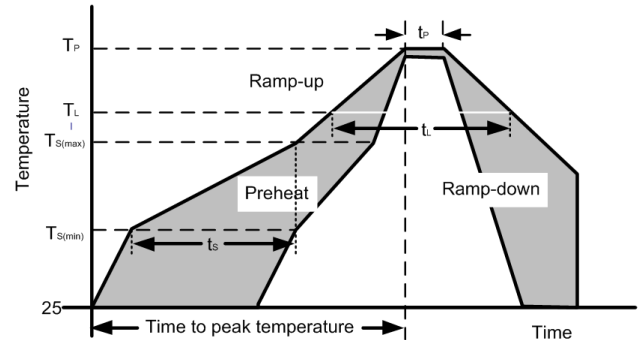

Outline Drawing – SMC (DO-214AB)

Ref. (mm)	Millimeters	
	Min.	Max.
A	2.06	2.70
A1	-	0.30
B	2.90	3.20
E	6.60	7.40
E1	7.75	8.13
D	5.59	6.22
L	0.76	1.52

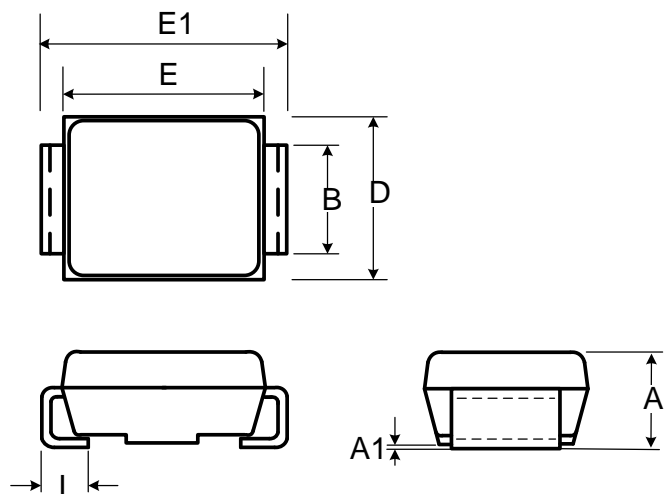

Recommended Solder Pad Layout

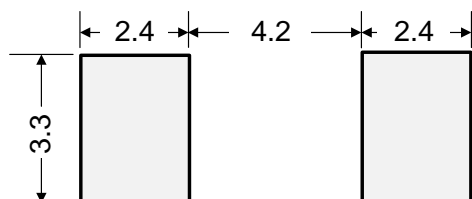

Dimensions in mm

Part Numbering System

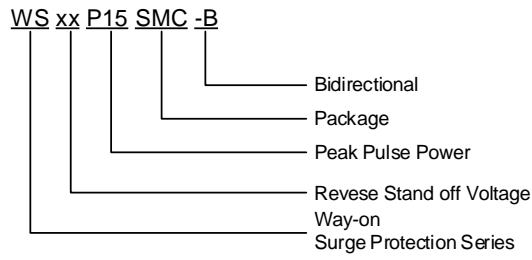

Part Marking System

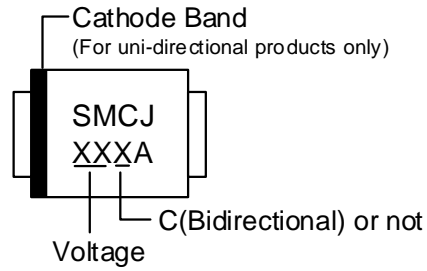

Package Information

Package Type	Description	Quantity (pcs)	Standard
SMC(DO-214AB)	Tape & Reel -16mm/13" tape	3000	EIA-481-D

Tape and Reel Information

RD	Reel Dimensions	13 inch
W	Overall width of the carrier tape	16 mm
P1	Pitch between successive cavity centers	8 mm

Reel Dimensions

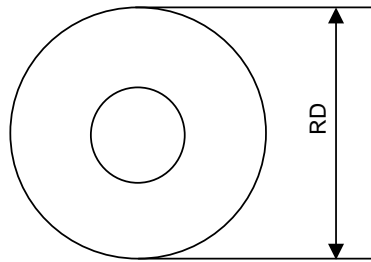

Tape Dimensions

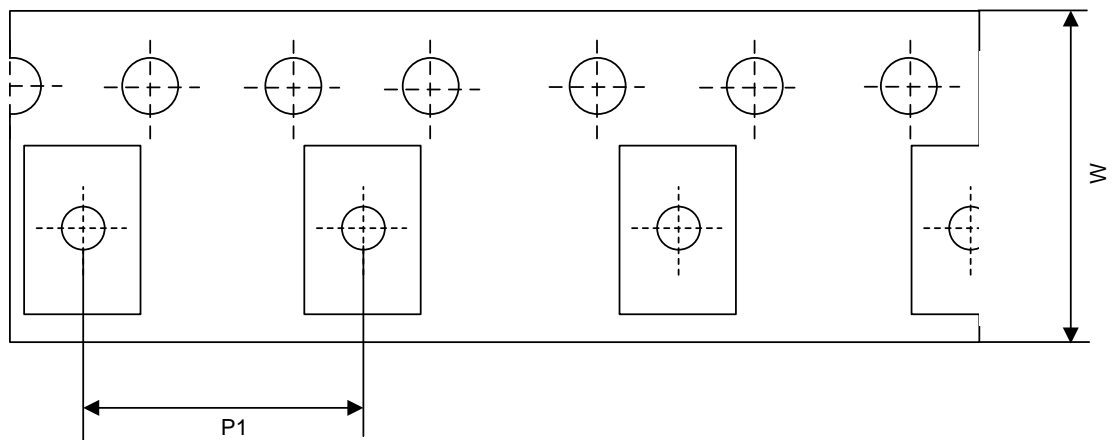

Quadrant Assignments for PIN1 Orientation in tape

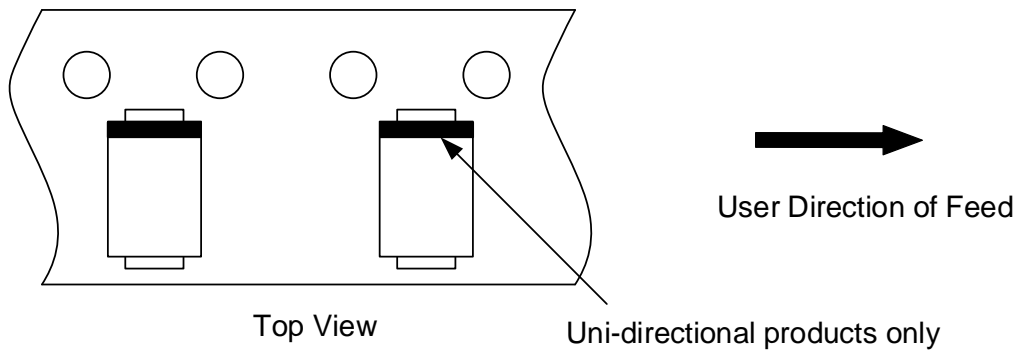

Contact Information

No.1001, Shiwan(7) Road, Pudong District, Shanghai, P.R.China.201207

Tel: 86-21-50310888 Fax: 86-21-50757680 Email: market@way-on.com

WAYON website: <http://www.way-on.com>

For additional information, please contact your local Sales Representative.

WAYON® is registered trademarks of Wayon Corporation.

Product Specification Statement

The product specification aims to provide users with a reference regarding various product parameters, performance, and usage. It presents certain aspects of the product's performance in graphical form and is intended solely for users to select product and make product comparisons, enabling users to better understand and evaluate the characteristics and advantages of the product. It does not constitute any commitment, warranty, or guarantee.

The product parameters described in the product specification are numerical values, characteristics, and functions obtained through actual testing or theoretical calculations of the product in an independent or ideal state. Due to the complexity of product applications and variations in test conditions and equipment, there may be slight fluctuations in parameter test values. WAYON shall not guarantee that the actual performance of the product when installed in the customer's system or equipment will be entirely consistent with the product specification, especially concerning dynamic parameters. It is recommended that users consult with professionals for product selection and system design. Users should also thoroughly validate and assess whether the actual parameters and performance when installed in their respective systems or equipment meet their requirements or expectations. Additionally, users should exercise caution in verifying product compatibility issues, and WAYON assumes no responsibility for the application of the product.

WAYON strives to provide accurate and up-to-date information to the best of our ability. However, due to technical, human, or other reasons, WAYON cannot guarantee that the information provided in the product specification is entirely accurate and error-free. WAYON shall not be held responsible for any losses or damages resulting from the use or reliance on any information in these product specifications. WAYON reserves the right to revise or update the product specification and the products at any time without prior notice, and the user's continued use of the product specification is considered an acceptance of these revisions and updates. Prior to purchasing and using the product, users should verify the above information with WAYON to ensure that the product specification is the most current, effective, and complete. If users are particularly concerned about product parameters, please consult WAYON in detail or request relevant product test reports. Any data not explicitly mentioned in the product specification shall be subject to separate agreement.

Users are advised to pay attention to the parameter limit values specified in the product specification and maintain a certain margin in design or application to ensure that the product does not exceed the parameter limit values defined in the product specification. This precaution should be taken to avoid exceeding one or more of the limit values, which may result in permanent irreversible damage to the product, ultimately affecting the quality and reliability of the system or equipment.

The design of the product is intended to meet civilian needs and is not guaranteed for use in harsh environments or precision equipment. It is not recommended for use in systems or equipment such as medical devices, aircraft, nuclear power, and similar systems, where failures in these systems or equipment could reasonably be expected to result in personal injury. WAYON shall assume no responsibility for any consequences resulting from such usage.

Users should also comply with relevant laws, regulations, policies, and standards when using the product specification. Users are responsible for the risks and liabilities arising from the use of the product specification and must ensure that it is not used for illegal purposes. Additionally, users should respect the intellectual property rights related to the product specification and refrain from infringing upon any third-party legal rights. WAYON shall assume no responsibility for any disputes or controversies arising from the above-mentioned issues in any form.